

Applications

- Small Front of house system
- Compact monitor
- Frontfill / Nearfill / Background

Features + Benefits

- Passive 8" / 1" loudspeaker system
- Rotatable CD horn
- Bi-functional enclosure design
- U-bracket
- Wide range of accessories

A complex passive crossover matches the components working perfectly together and allows full-range application without additional electronics.

You can use the Flex8 as a small FoH speaker, as a compact wedge, as a near-fill, or in combination with our Flex-Series Subs as a mid-high unit.

For easy and efficient cable connection as a wedge or near-fill, 4 Speakon NL4 are available. Two connectors are on the bottom and two are on the rear of the enclosure.



Type	Flex8
Enclosure	12 mm birch plywood with structure paint and monitor angles
Basic layout	2-way passive system,
Protective Grille	bass-reflex tuning 1.5 mm grille, covered with
Components	acoustic foam 8" neodymium low-mid speaker 1" ND compression driver with 1.7" voice coil rotatable CD-Horn passive crossover with phase correction
Frequency Response	100 Hz-20 kHz +/-3 dB
Power handling RMS peak	250 W RMS 1.000 W Peak
Nominal Impedance	16 Ω
Dispersion pattern	90° x 60°
Sensitivity	95 dB
SPLmax	125 dB peak 1 m
Connectors	NL4: 1+/1- on rear and bottom (2 each)
Dimensions (w x h x d)	248 x 414 x 224 mm
net weight	9 kg
Accessories	U-bracket, quad flight case transport cover, transport bag

Horizontal coverage pattern

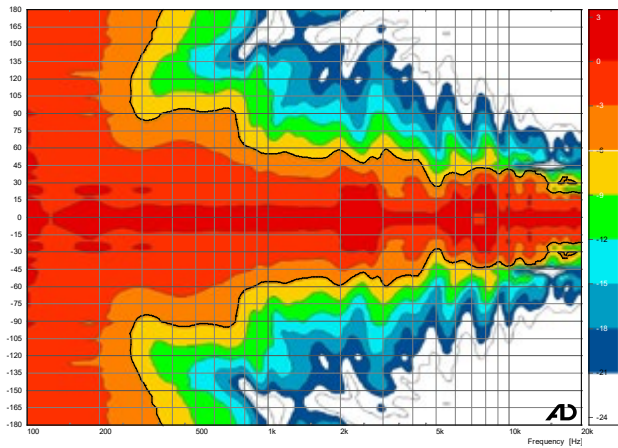

Vertical coverage pattern

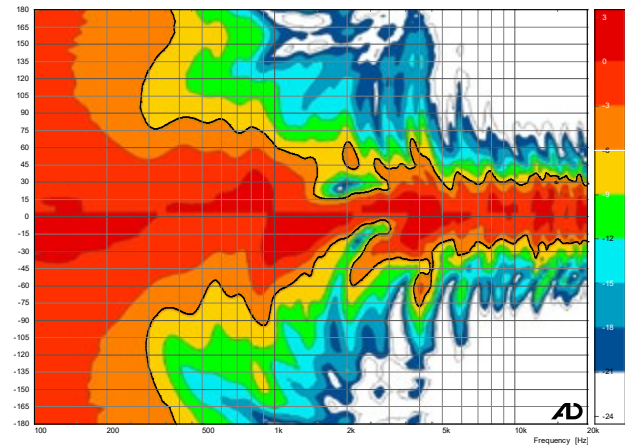

Sensitivity / Processed Sensitivity

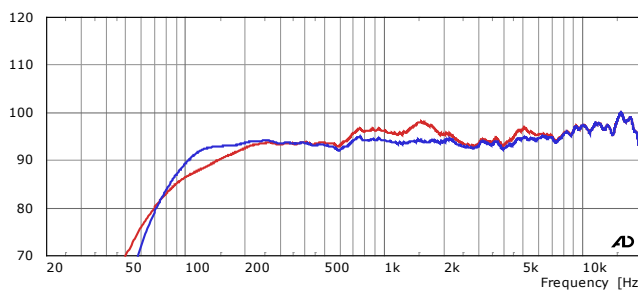

Impedance

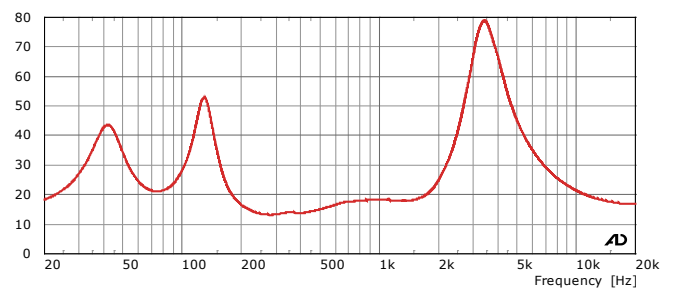

Notes on performance data and graphs:

- 2) Frequency response: Range of the processed response -6db
- 3) Power Handling: Is based on the AES power handling of the transducers.
- 4) Nominal Sensitivity: SPL at 1 Watt at nominal impedance, referenced to 1 Meter.

- 5) Measurement condition: Full space in the far field of the speaker. Time-windowed
- 6) Maximum SPL: Calculated from nominal sensitivity at stated peak input power.
- 7) Resolution: For better readability a 1/6 octave smoothing is applied.

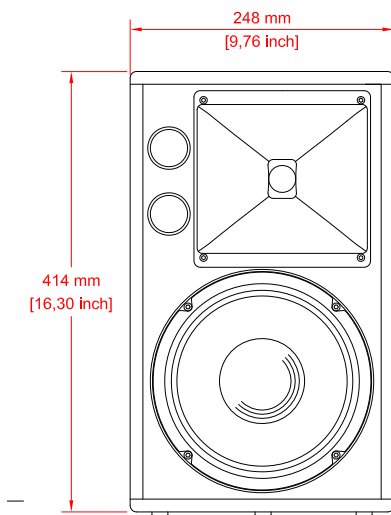

Front

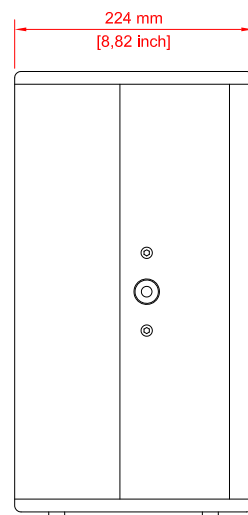

Side

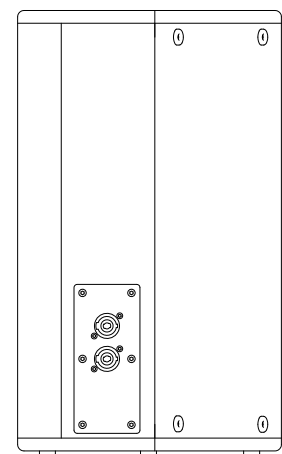

Rear

