

Front

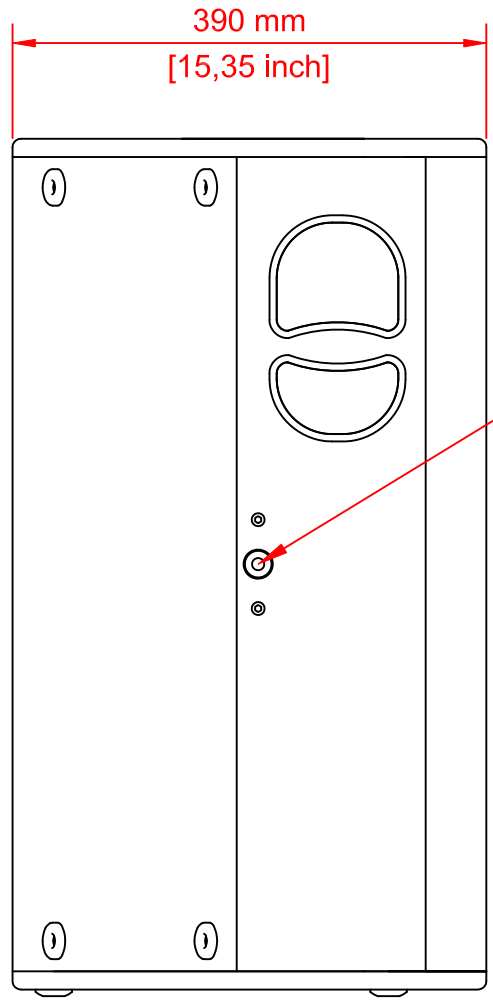

Side

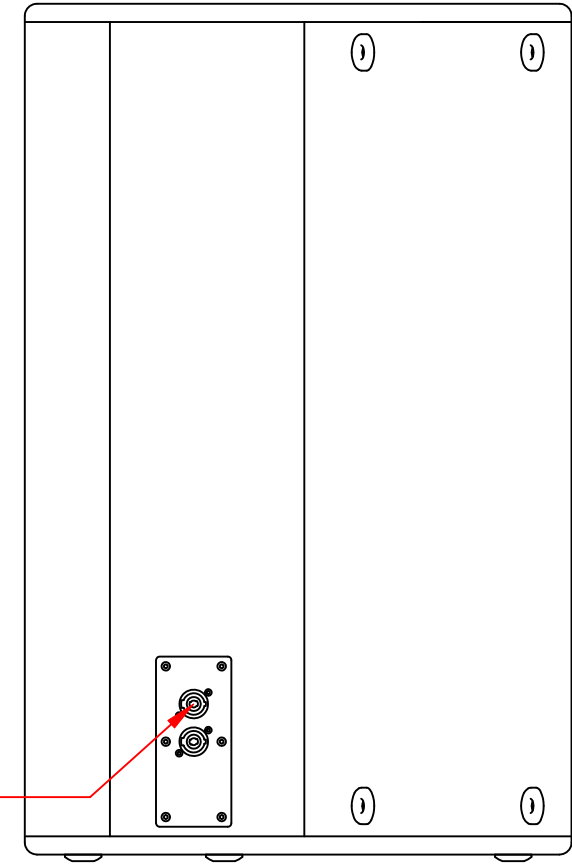

Rear

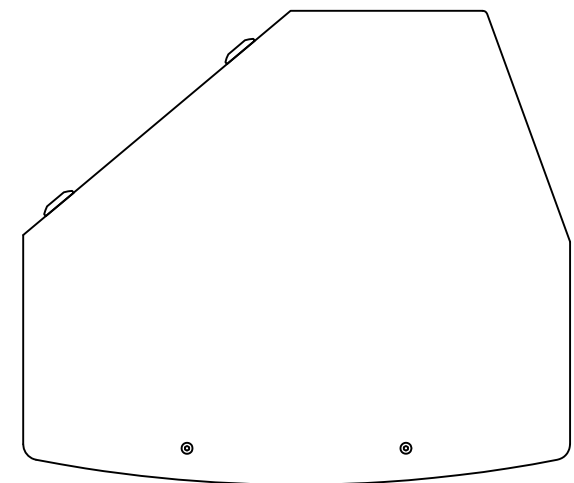

Top

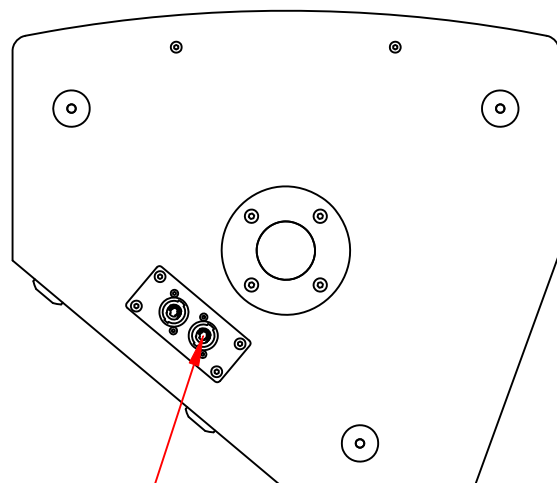

Bottom

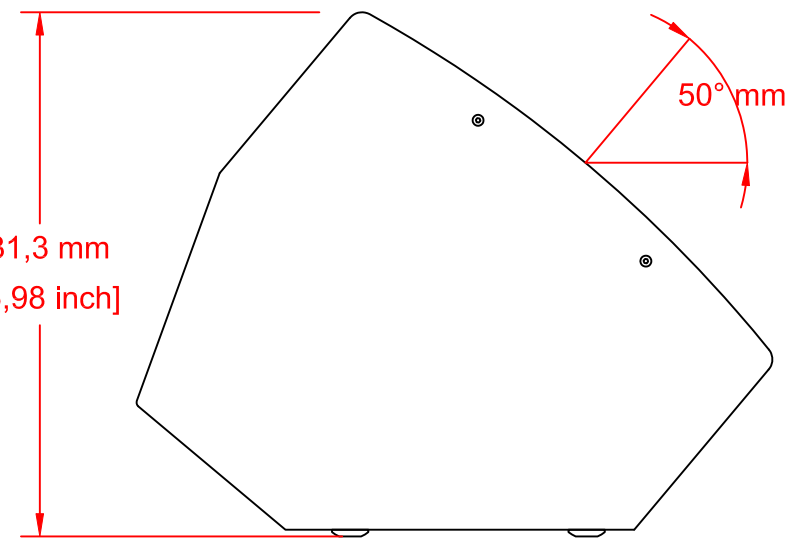

Monitor

Flex15	
FILE NAME	flex12.dwg
DATE	02.03.2009
DRAWN BY	S.Haferkamp
Rev.	1.0
AD-Systems GmbH & Co. KG Am Schornacker 11c D-46485 Wesel www.ad-systems.com info@ad-systems.com	

