

Front

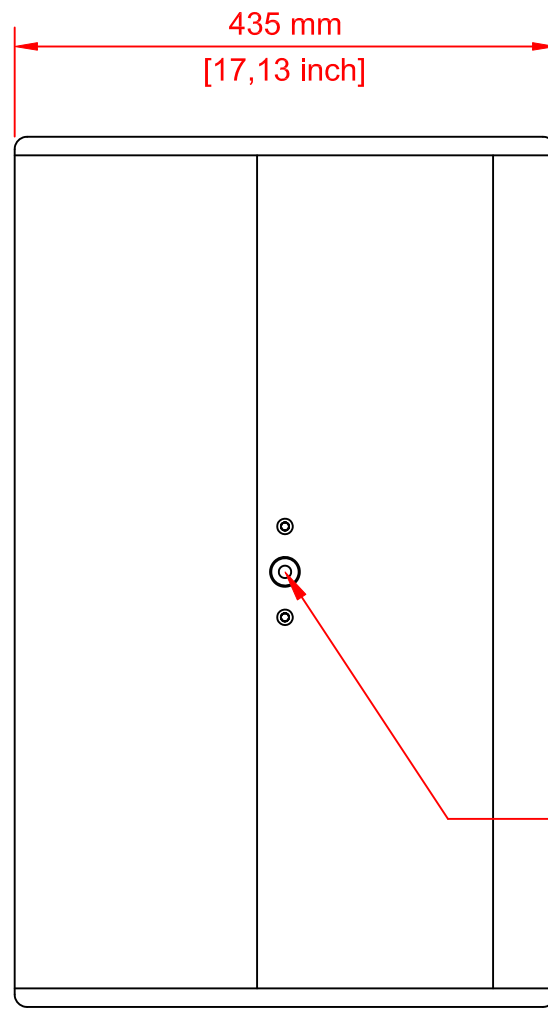

Side

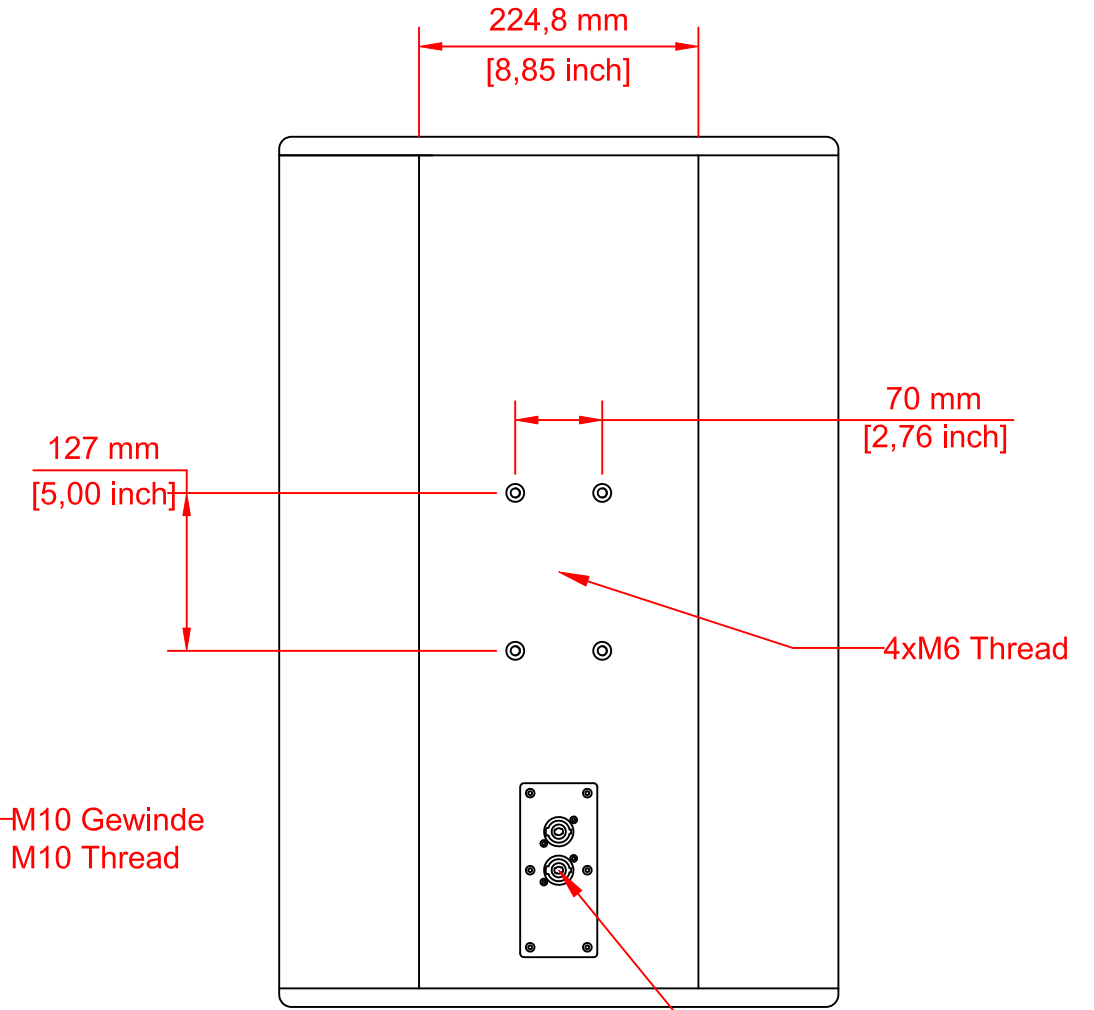

Rear

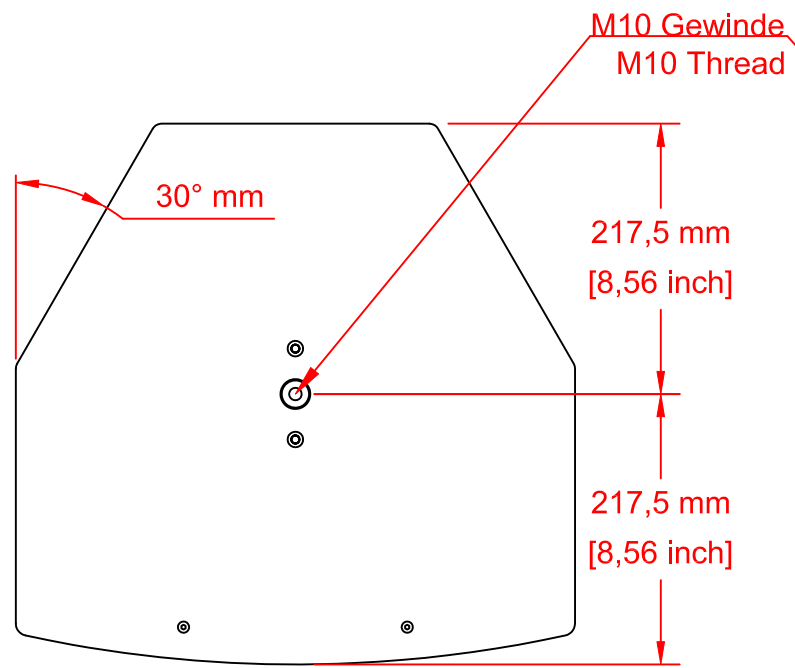

Top

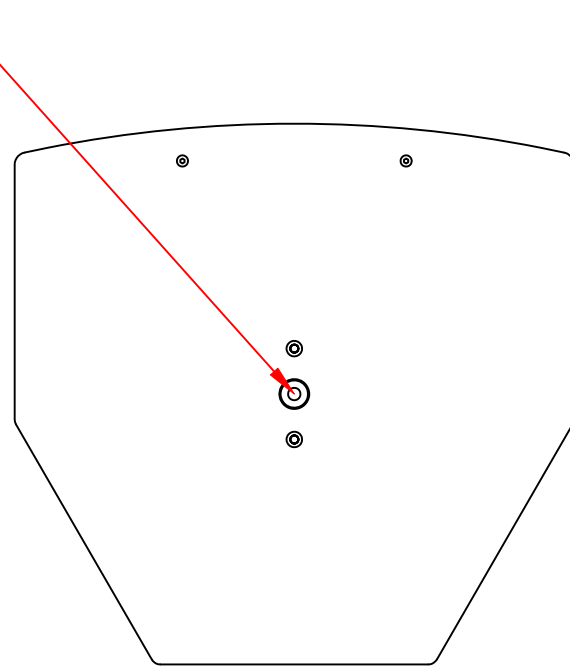

Bottom

iFlex15.2

FILE NAME	iflex151.dwg
DATE	17.01.2013
DRAWN BY	S.Haferkamp
Rev.	1.1

AD-Systems GmbH & Co. KG
 Am Schornacker 11c
 D-46485 Wesel
 www.ad-systems.com
 info@ad-systems.com

